

# 60" PORTABLE TABLE TENNIS SET - NG2305P

## Spec Sheet

UPC Code: 672875903702

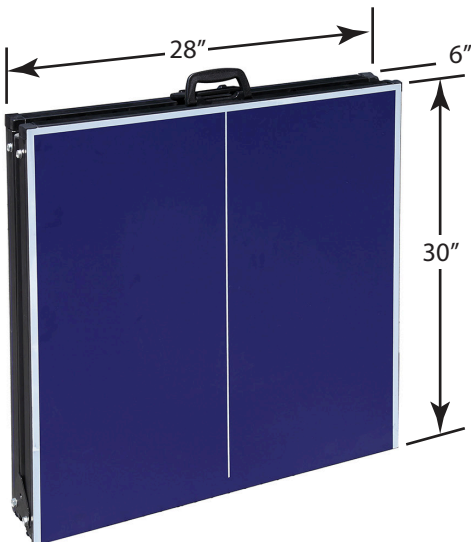
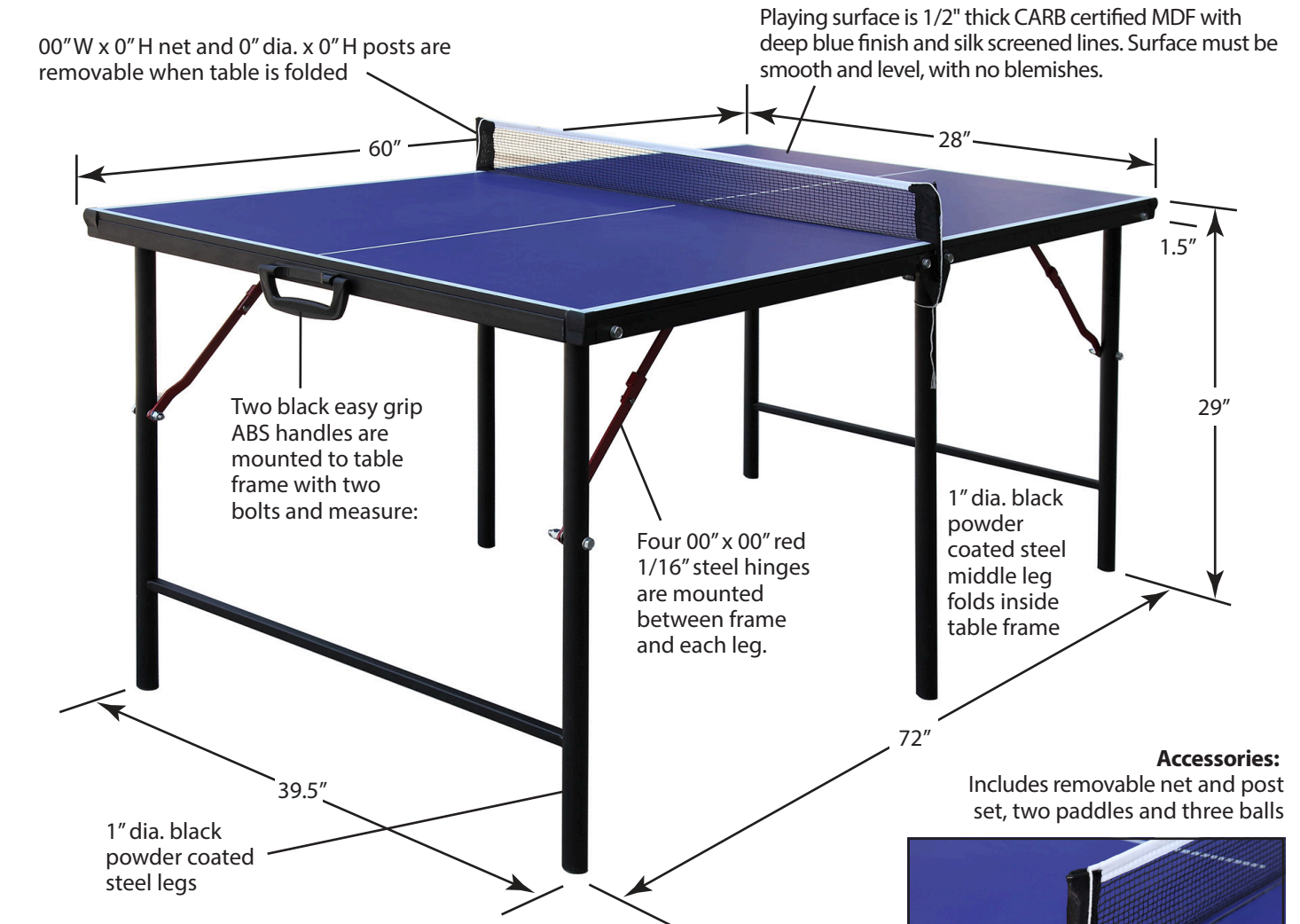

Folded size for carrying and storage



Black ABS suitcase style carrying handle

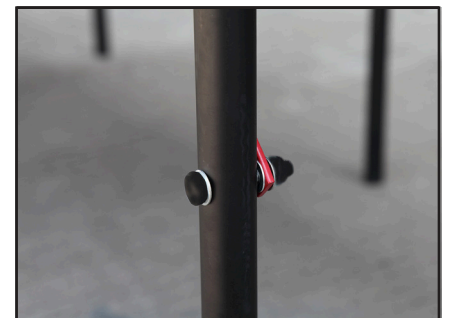
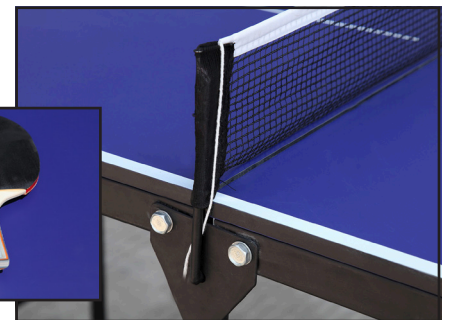







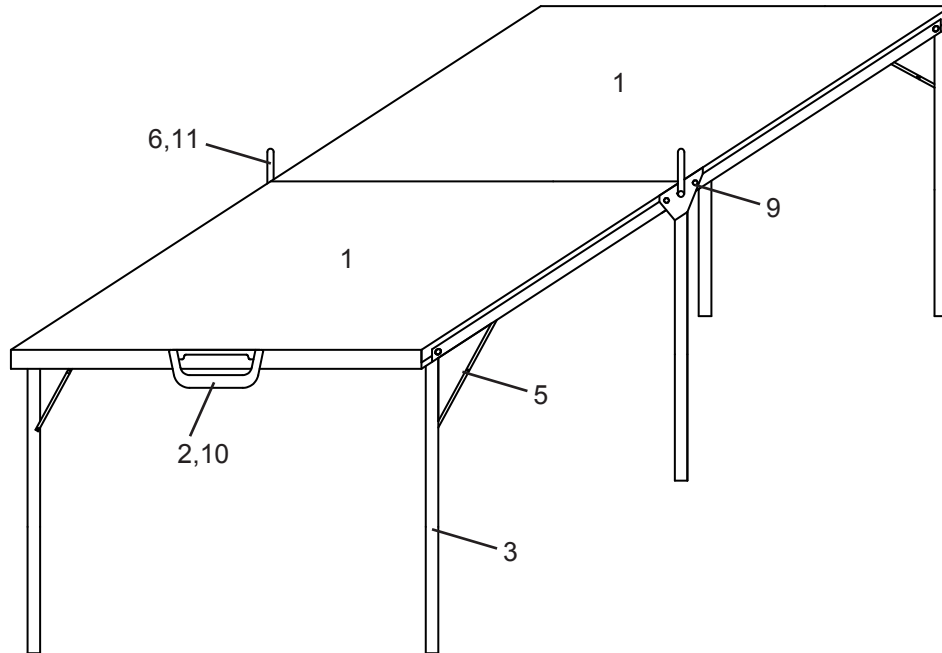



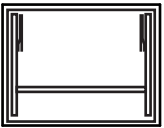
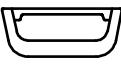

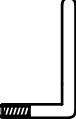

Hinge to leg attachment detail

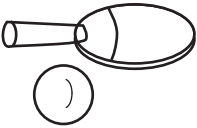
# 60" PORTABLE TABLE TENNIS SET - NG2305P

## Spec Sheet



### PARTS

<p>#1 NGP5985</p>  <p>TABLE TOP 2 pcs</p>	<p>#2 NGP5986</p>  <p>HANDLE 2 pcs</p>	<p>#3 NGP5987</p>  <p>LEG 4 pcs</p>	<p>#4 NGP5988</p>  <p>MIDDLE LEG 2 pcs</p>	<p>#5 NGP5989</p>  <p>HINGE 4 pcs</p>
<p>#6 NGP5990</p>  <p>NET POST 2 pcs</p>	<p>#7 NGP5991</p>  <p>NET 1 pc</p>	<p>#8 NGP5944</p>  <p>PADDLES &amp; BALLS SET 2 pcs &amp; 3 pcs</p>	<p>#9 NGP5992*</p>  Bolt  Washer  Nut <p>M8x30 BOLT SET 4 pcs</p>	<p>#10 NGP5992*</p>  Screw  Washer <p>M5x30 SCREW SET 4 pcs</p>
<p>#11 NGP5992*</p>  Washer  Nut <p>M8 NUT/WASHER SET 2 pcs</p>				

\*Items included in Hardware Pack, NGP5992