

7' RICOCHET SHUFFLEBOARD TABLE - NG1201

Spec Sheet

UPC Code: 672875903160

Finish Color Sample

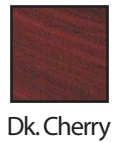

Side and End Aprons are 9.5" H 1/2" MDF (top rail is 1.125" W) with Dk. Cherry PVC laminate and capped with matte black ABS

Play surface is min. 1.5" thick solid finger jointed hardwood butcher block finished in a smooth gloss polyurethane w/poly-sealed underside. Play surface is 74" L x 20" W top lane and 14.5" W bottom lanes (30.625" W total)

Top ledges taper from 9" to 3.375", have Dk. Cherry PVC laminate, and each has two 3" dia. cup holders and recessed grey carpeted area for pucks

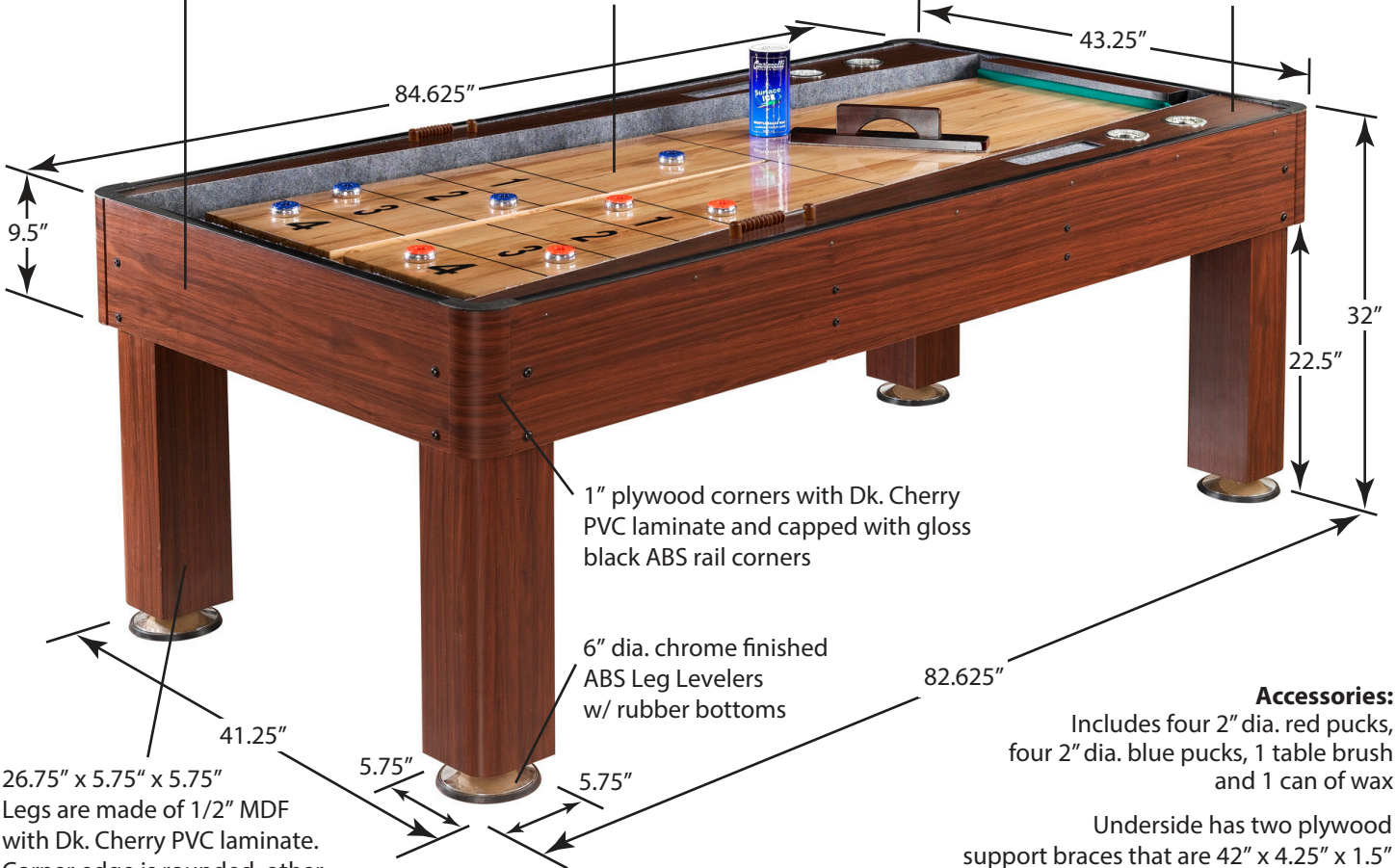

Accessories:
Includes four 2" dia. red pucks, four 2" dia. blue pucks, 1 table brush and 1 can of wax

Underside has two plywood support braces that are 42" x 4.25" x 1.5"

All structural components to be CARB certified MDF unless otherwise specified



Play surface must be smooth and level with NO dips over 1/32" in depth and NO visible filler (see photo above).



2.75" deep gutters are covered, bottom and sides, with grey, synthetic fiber, ribbed carpeting.

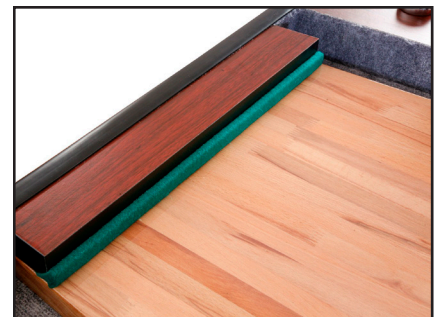

20" W x 1.125" H x 3.5" D rebound cushion is made of gum rubber covered in green blended polyester/wool cloth





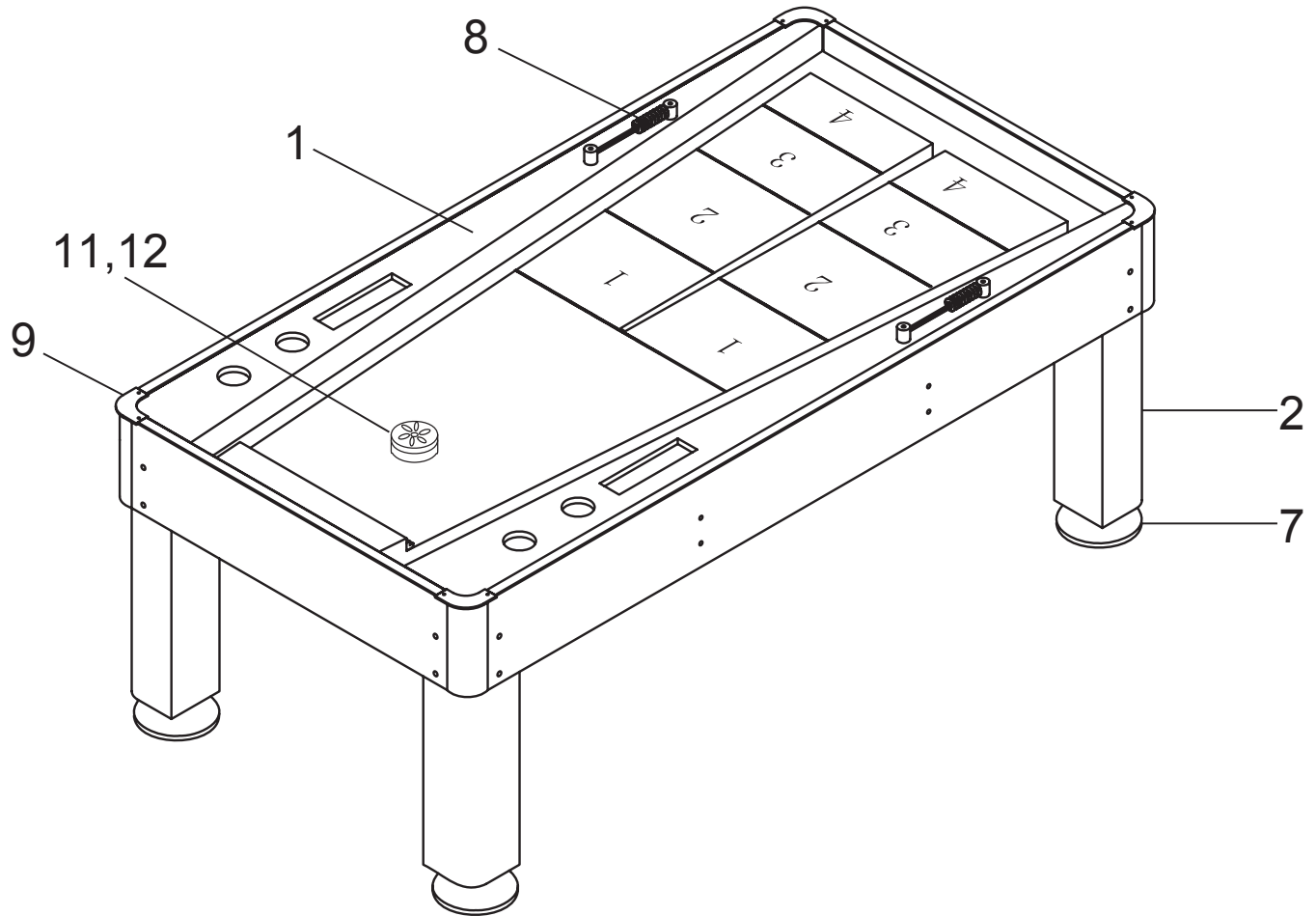

7' RICOCHET SHUFFLEBOARD TABLE - NG1201

Spec Sheet

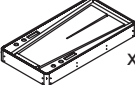
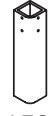







All dimensions given are approx. and represent the size at the widest point of that dimension.

PARTS

#1 NGP5891 84" x 43.25" x 9.5" 1/2" MDF  x1 TABLE BODY	#2 NGP5892 26.75" x 5.75" x 5.75" 1/2" MDF  x4 LEG	#7 NGP5893 6" Dia. x 2.5" ABS/Steel/Rubber  x4 LEG LEVELER	#8 NGP5894 16.75" x 1.25" x 1.25" Wood/Steel  x2 SLIDE SCORER	#9 NGP5895 3.5" x 3.5" x 1.25" ABS Plastic  x4 RAIL CORNER	#10 NGP1221 Med. Speed 16 oz. Can  x1 SHUFFLEBOARD WAX	#11 NGP2607 2" Dia. x .75", 9.5 oz. Polished Steel/ABS  x4 SHUFFLEBOARD PUCKS-BLUE	#12 NGP2606 2" Dia. x .75", 9.5 oz. Polished Steel/ABS  x4 SHUFFLEBOARD PUCKS-RED
--	--	--	---	--	--	--	---

HARDWARE PACK - NGP5896

#3 x16  M8X45MM BOLT	#4 x16  19MM WASHER	#5 x8  4X25MM FLAT HEAD SCREW	#6 x4  4X50MM FLAT HEAD SCREW	#13 x1  ALLEN WRENCH	ADDITIONAL EQUIPMENT REQUIRED:  PHILLIPS HEAD SCREWDRIVER
--	---	---	---	---	--