

# Enduraliner™ Measuring Form

For Custom In-Ground Pool Liners

Quote# \_\_\_\_\_

Date \_\_\_\_\_

Dealer Name \_\_\_\_\_

Pool Owner Name \_\_\_\_\_

Dealer Contact Name \_\_\_\_\_

Address \_\_\_\_\_

Address \_\_\_\_\_

City \_\_\_\_\_ St \_\_\_\_\_ Zip \_\_\_\_\_

City \_\_\_\_\_ St \_\_\_\_\_ Zip \_\_\_\_\_

Phone \_\_\_\_\_ Fax \_\_\_\_\_

Phone \_\_\_\_\_ Fax \_\_\_\_\_

E-Mail Address \_\_\_\_\_

Web Site Address \_\_\_\_\_

Email quotes to [customerservice@pcpools.com](mailto:customerservice@pcpools.com)

Your Signature \_\_\_\_\_

Your signature indicates that you have verified your measurements and that the information you have provided is correct. Your new vinyl liner will be made to these specifications once you place your order. (Orders cannot be processed without your signature)

## 1 LINER PATTERN

Pattern Name: \_\_\_\_\_

Mil (check one):  20mil  28mil

## 2 CORNER TYPE

Check your corner type below & enter measurements where required:

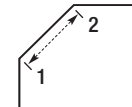
Cut Corner  Point 1 to Point 2: \_\_\_\_\_

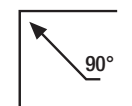
90 Degree Corner  No measurements required for square corners.

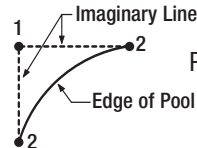
Radius/Rounded Corner  Point 1 to Point 2: \_\_\_\_\_

## 3 LINER TYPE

Beaded

Low Hung Beaded

Overlap  
How many inches of liner do you need for the overlap? \_\_\_\_\_

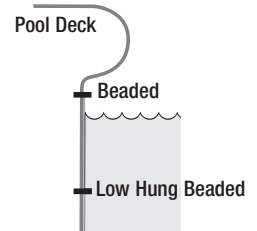

If you selected "Beaded" or "Low Hung Beaded," please also indicate below if your liner is a **Standard** or **Reverse** bead:

Standard Bead

Reverse Bead

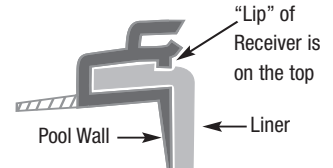
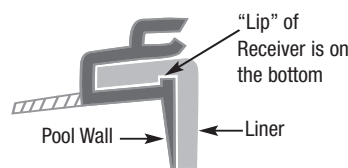

## 4 HOPPER TYPE

Check one & fill in measurements on the form to the right:

A. Standard Hopper

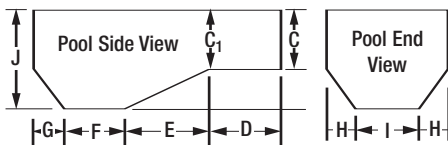

B. Wedge Hopper

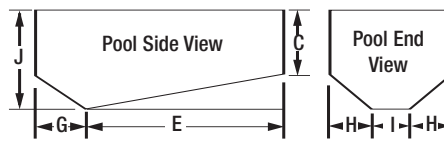

C. Constant Slope Hopper

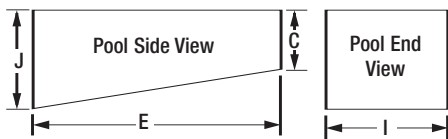

D. Safety Ledge Hopper

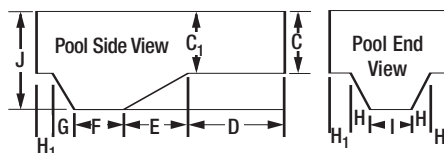

Fill in all measurements that apply to your hopper type:

C \_\_\_\_\_ ft \_\_\_\_\_ in

C<sub>1</sub> \_\_\_\_\_ ft \_\_\_\_\_ in

D \_\_\_\_\_ ft \_\_\_\_\_ in

E \_\_\_\_\_ ft \_\_\_\_\_ in

F \_\_\_\_\_ ft \_\_\_\_\_ in

G \_\_\_\_\_ ft \_\_\_\_\_ in

H \_\_\_\_\_ ft \_\_\_\_\_ in

H<sub>1</sub> \_\_\_\_\_ ft \_\_\_\_\_ in

I \_\_\_\_\_ ft \_\_\_\_\_ in

J \_\_\_\_\_ ft \_\_\_\_\_ in

### Are you measuring the bottom of your pool correctly?

Be sure you are **NOT** measuring the slopes when taking horizontal bottom measurements. We only use measurements parallel to the deck. See the diagrams below for the correct way to measure a coved bottom.

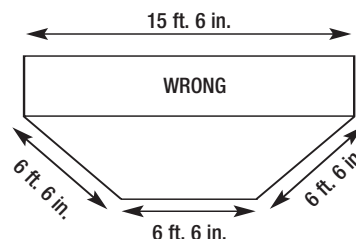
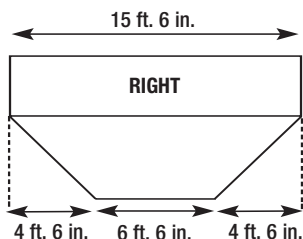

Email quotes to [customerservice@pcpools.com](mailto:customerservice@pcpools.com)

**POOL SHAPE**

**Check one & fill in the measurements below:**

NOTE: Diagonal measurements must be taken to imaginary squared off corners of your pool if you have radius or cutoff corners. (i.e. diagonal measurement Q & R on the rectangular pool)

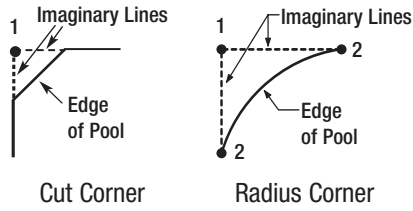

Measure to imaginary point 1, NOT the edge of the pool

**Dimensions:** Please transfer all of the measurements you have taken into the appropriate spaces below. NOTE: you may not use all the letters below, depending on your pool shape.

Rectangular

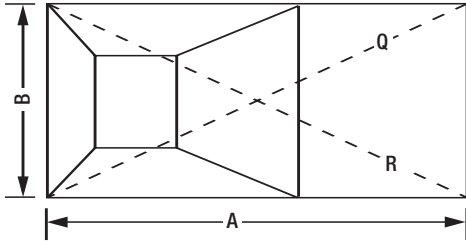

- |                                  |                     |
|----------------------------------|---------------------|
| A _____ ft _____ in              | M _____ ft _____ in |
| A <sub>1</sub> _____ ft _____ in | N _____ ft _____ in |
| A <sub>2</sub> _____ ft _____ in | O _____ ft _____ in |
| B _____ ft _____ in              | P _____ ft _____ in |
| B <sub>1</sub> _____ ft _____ in | Q _____ ft _____ in |
| B <sub>2</sub> _____ ft _____ in | R _____ ft _____ in |
| K _____ ft _____ in              | W _____ ft _____ in |
| L _____ ft _____ in              | X _____ ft _____ in |

True "L" Left

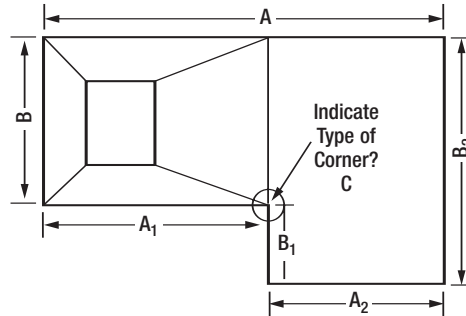

**C (Corner Type) Applies to True "L" Left & Right ONLY:**

Cut Corner

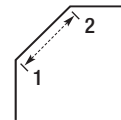

Point 1 to Point 2: \_\_\_\_\_

90 Degree Corner



No measurements required for square corners.

Radius/Rounded Corner

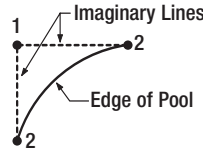

Point 1 to Point 2: \_\_\_\_\_

True "L" Right

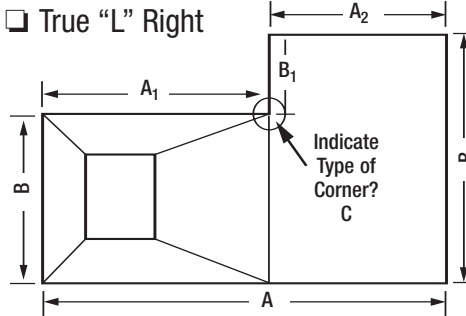

Contour Bottom Grecian

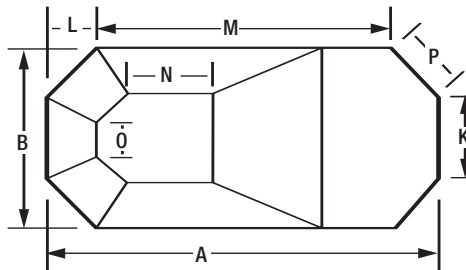

Square Bottom Grecian

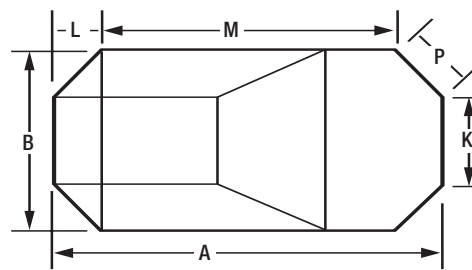

Oval with Parallel Sides

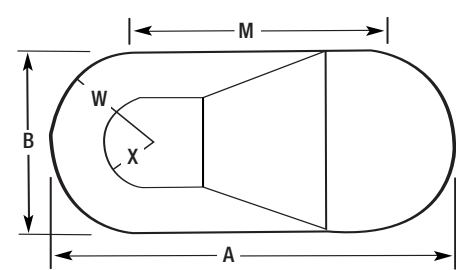

**VINYL COVERED STEPS**

Please check one:

- Fiberglass (No Further Measurements Needed)
- Vinyl Covered (Fill Out the Section on Pg. 3)
- No Steps

Email quotes to  
customerservice@pcpools.com

**What is the Step Position?**

Please circle the position that best describes the location of your step and provide measurements (Y) and (A).

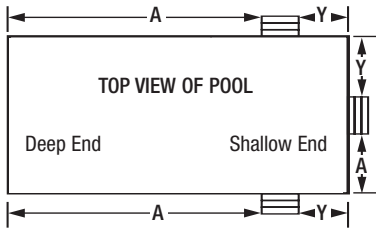

Record Measurements  
(Y) & (A) below:

Y = \_\_\_\_\_ ft \_\_\_\_\_ in

A = \_\_\_\_\_ ft \_\_\_\_\_ in

**Top Step Corners**

- Square
- Radius \_\_\_\_\_ in
- Diagonal \_\_\_\_\_ in

**Rod Pockets**     Yes     No  
Size \_\_\_\_\_  
(Diameter of Rod)

**Step Setback**     Yes     No  
If yes, see below

Setback width (K) \_\_\_\_\_ in

**Nailer Flaps**     Yes     No

Straight     Angled (L) \_\_\_\_\_ in

	A	
	B	
*	C	
**	D	
**	E	
**	F	
***	G	
***	H	
***	I	
***	J	
	K	
	L	

**IMPORTANT: \* C must equal wall height of shallow end**  
**\*\* D+E+F Must equal B**  
**\*\*\* G+H+I+J Must equal C**

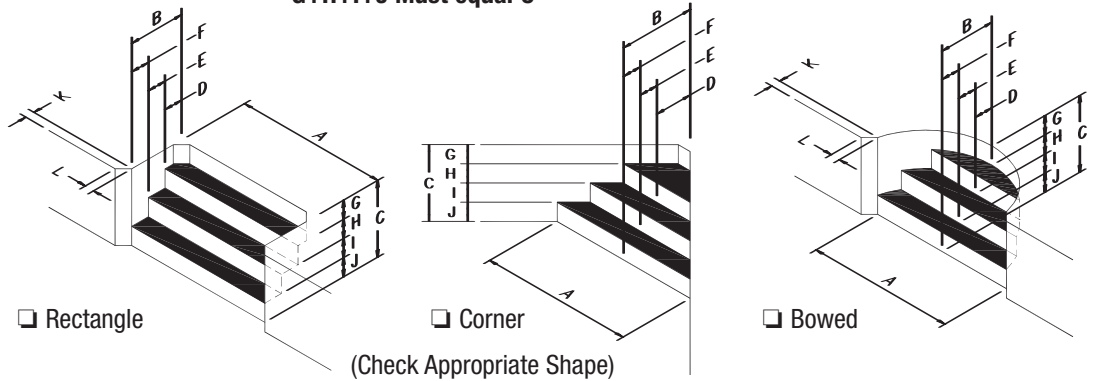

**HELPFUL HINTS**

**Measuring the pool bottom without entering the pool:**

You will be able to make horizontal measurements of you pool bottom without entering the pool. Taking these measurements is easier than you may think, when you use this easy-to-make measuring tool.

**You will need:**

1. A long straight pole (telepole) – “fishing pole”
2. String attached to one end of the pole
3. Some sort of weight tied to the other end of the string
4. A measuring tape

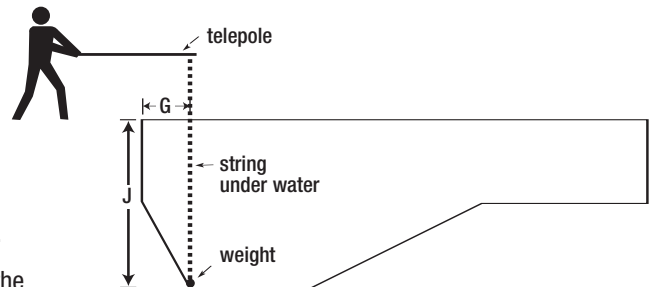

Follow the instructions below, using your fishing pole, to make these measurements.

**Horizontal Bottom Measurements:** Use your “fishing pole” to “fish” for a point on the bottom of the pool. With the pole to the ends of the pool and the string vertical (allow no slack in the string), measure the distance from the edge of the pool (water’s edge) to the end of the pole where string is attached. You should “fish” for points that will achieve the desired measurements based on the bottom contour of your pool (pictured on page 1).

For example, to take measurement (H), you would stand on one side of the pool, and “fish” for a corner of the Hopper. You would then measure the distance from the edge of the pool (water’s edge) to the end of the pole where the string is attached.

**Depth measurements:** When taking the depth measurements (C) and (J), be sure to measure from the bottom of the pool floor to the bead receiver (for beaded liners) OR to the board where the liner is nailed or stapled (for overlap liners). Do **not** measure to the top of the pool if you have a bead receiver, your measurement will be incorrect.

# VINYL COVERED STEPS

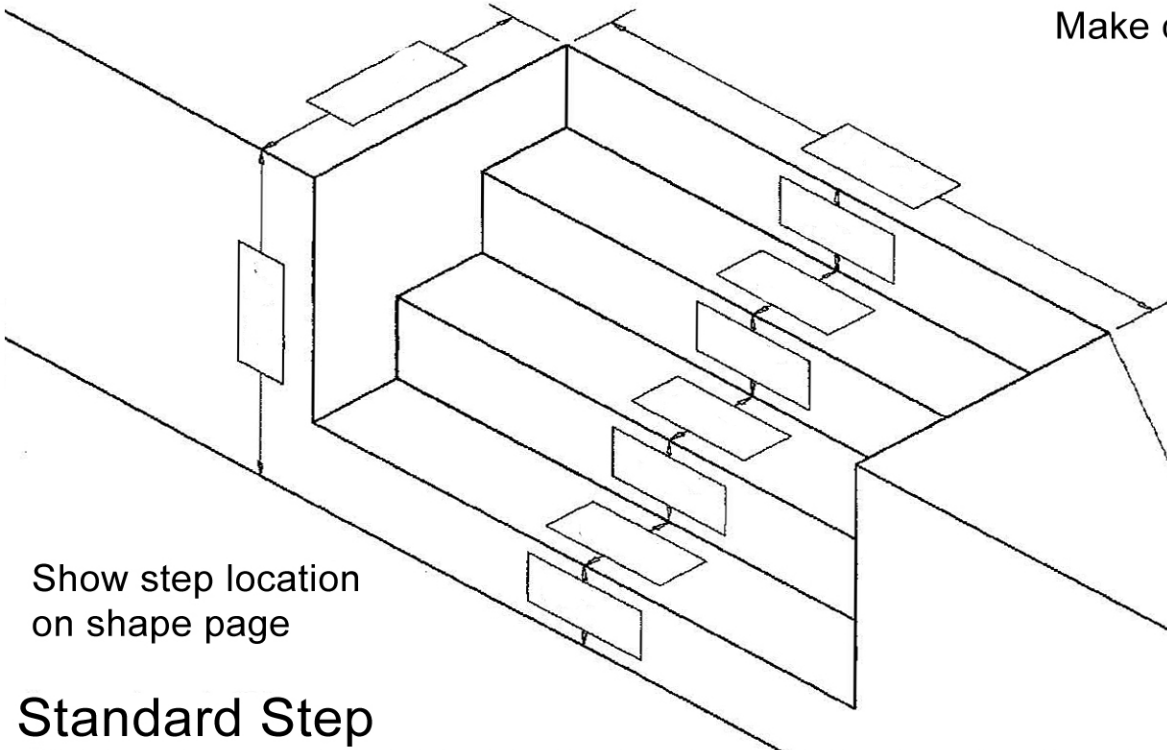

Show step location  
on shape page

## Standard Step

Make of Step \_\_\_\_\_

Do you require rod  
pockets? \_\_\_\_\_

Radius*

Cut Corner

\*Write 0 if square

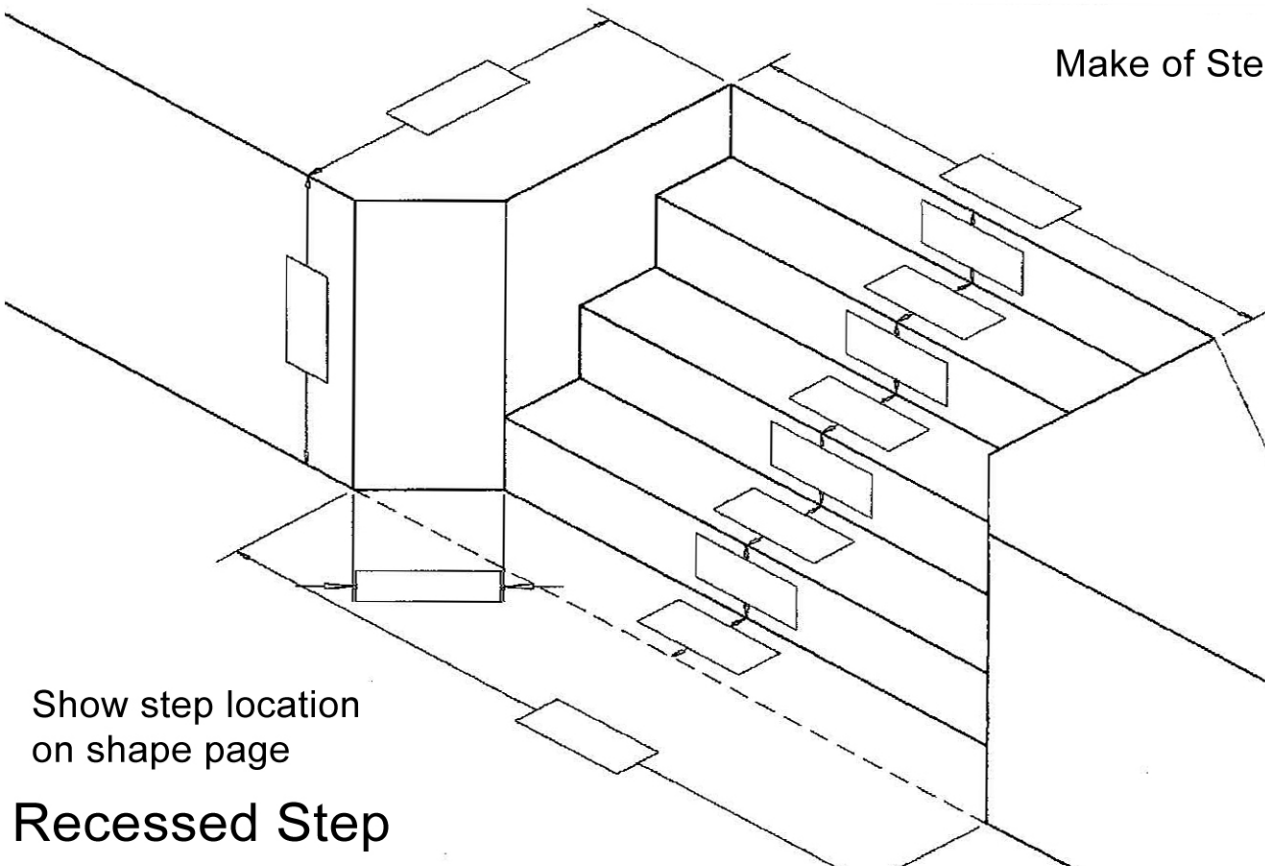

Show step location  
on shape page

## Recessed Step

Make of Step \_\_\_\_\_

Do you require rod  
pockets? \_\_\_\_\_

Radius*

Cut Corner

\*Write 0 if square